



 **TABIB**
surgical

**ORTHOPEDIC
INSTRUMENTS**
CATALOGUE 2022























			Fig. 0000 TS-266-08		Fig. 0000 TS-266-18
			Fig. 000 TS-266-09		
	Fig. 000 TS-266-01				Fig. 000 TS-266-19
			Fig. 00 TS-266-10		
	Fig. 00 TS-266-02				Fig. 00 TS-266-20
			Fig. 0 TS-266-11		
	Fig. 0 TS-266-03				Fig. 0 TS-266-21
			Fig. 1 TS-266-12		
	Fig. 1 TS-266-04				Fig. 1 TS-266-22
			Fig. 2 TS-266-13		
	Fig. 1 TS-266-04				Fig. 2 TS-266-23
			Fig. 3 TS-266-14		
	Fig. 2 TS-266-05				Fig. 3 TS-266-24
			Fig. 4 TS-266-15		
	Fig. 3 TS-266-06				Fig. 4 TS-266-25
			Fig. 5 TS-266-16		
	Fig. 3 TS-266-06				Fig. 5 TS-266-26
SCHEDE 17,0 cm, 6 ³ / ₄ "	Fig. 4 TS-266-07		Fig. 6 TS-266-17		
		VOLKMANN 17,0 cm, 6 ³ / ₄ "			Fig. 6 TS-266-27
					

Fig. 00000
TS-267-28

Fig. 0000
TS-267-29

Fig. 000
TS-267-30

Fig. 00
TS-267-31

Fig. 0
TS-267-32



Fig. 00
TS-267-33

Fig. 0
TS-267-34

Fig. 1
TS-267-35



Fig. 00
TS-267-36

Fig. 0
TS-267-37

Fig. 1
TS-267-38

Fig. 2
TS-267-39



WILLIGER
17,0 cm, 6³/₄"

Fig. 1
TS-268-40

Fig. 2
TS-268-41



WILLIGER
14,0 cm, 5¹/₂"

Fig. 0
TS-268-42

Fig. 1
TS-268-43

Fig. 2
192-406-02



MARTINI
14,0 cm, 5¹/₂"

Fig. 00/0
TS-268-44
14,0 cm, 5¹/₂"

Fig. 0/1
TS-268-45
14,0 cm, 5¹/₂"

Fig. 1/2
TS-268-46
14,0 cm, 5¹/₂"



VOLKMANN

TS-268-47
13,0 cm, 5"

TS-268-48
14,0 cm, 5¹/₂"

TS-268-49
17,0 cm, 6³/₄"

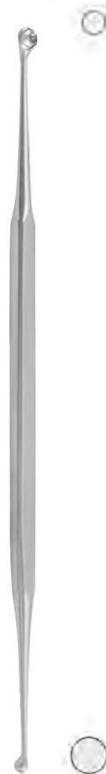

JANSEN
16,0 cm, 6¹/₄"

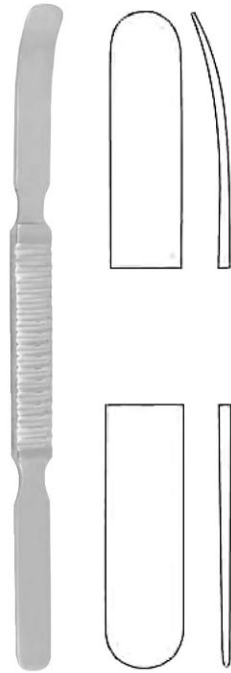

WATSON-CHEYNE
17,5 cm, 6⁵/₈"
TS-269-01



MC DONALD
19,0 cm, 7¹/₂"
TS-269-02



WILLIGER
17,0 cm, 6³/₄"
TS-269-03



WILLIGER
16,0 cm, 6¹/₄"
TS-269-04

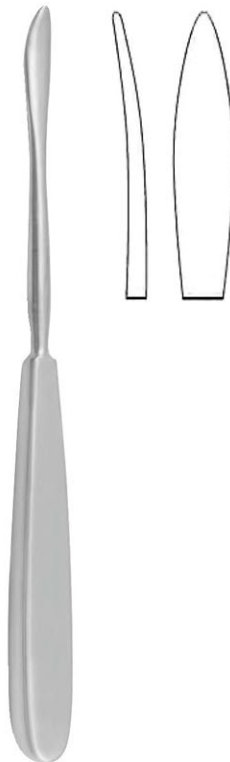

LANGENBECK
20,0 cm, 8"
TS-269-05



LANGENBECK
20,0 cm, 8"
TS-269-06
TS-268-50



ADSON
17,0 cm, 6³/₄"



8 mm
TS-270-01



7 mm
TS-270-02



7 mm
TS-270-03



7 mm
TS-270-04



KÖNIG
15,5 cm, 6"
TS-270-05



5 mm



LAMBOTTE
21,0 cm, 8¹/₄"



10 mm
TS-270-06



15 mm
TS-270-07

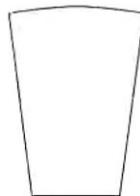

20 mm
TS-270-08



25 mm
TS-270-09

12,5 mm



FARABEUF
15,0 cm, 6"
TS-270-10



12,5 mm

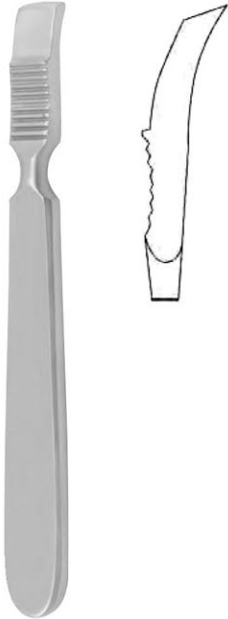

FARABEUF
15,0 cm, 6"
TS-271-01

16,0 mm

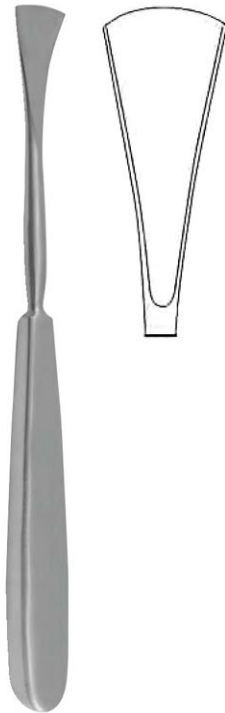

LANGENBECK
19,0 cm, 7 1/2"
TS-271-02

15,0 mm



SEDILLOT
21,0 cm, 8 1/4"
TS-271-03



4 mm **TS-271-04**
6 mm **TS-271-05**
8 mm **TS-271-06**

WILLIGER
16,0 cm, 6 1/4"



für Kinder
for children
para niños
per bambini

DOYEN
17,0 cm, 6 3/4"
TS-271-07



für Kinder
for children
para niños
per bambini

DOYEN
17,0 cm, 6 3/4"
TS-271-08



für Erwachsene
for adults
para adultos
per adulti

DOYEN
17,0 cm, 6 3/4"
TS-271-09



für Erwachsene
for adults
para adultos
per adulti

DOYEN
17,0 cm, 6 3/4"
TS-271-10

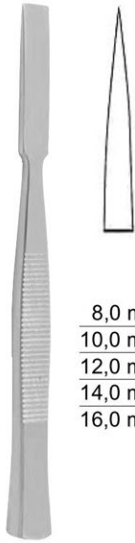

8,0 mm	TS-272-01
10,0 mm	TS-272-02
12,0 mm	TS-272-03
14,0 mm	TS-272-04
16,0 mm	TS-272-05

13,5 cm, 5³/₈"



8,0 mm	TS-272-06
10,0 mm	TS-272-07
12,0 mm	TS-272-08
14,0 mm	TS-272-09
16,0 mm	TS-272-10

13,5 cm, 5³/₈"

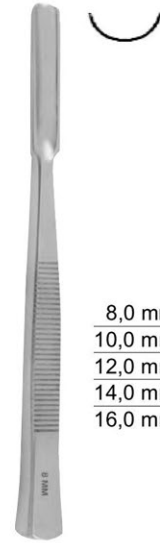

8,0 mm	TS-272-11
10,0 mm	TS-272-12
12,0 mm	TS-272-13
14,0 mm	TS-272-14
16,0 mm	TS-272-15

13,5 cm, 5³/₈"



3,0 mm	TS-272-16
4,0 mm	TS-272-17
5,0 mm	TS-272-18
6,0 mm	TS-272-19

PARTSCH
13,5 cm, 5³/₈"



3,0 mm	TS-272-20
4,0 mm	TS-272-21
5,0 mm	TS-272-22
6,0 mm	TS-272-24

PARTSCH
13,5 cm, 5³/₈"



10,0 mm	TS-272-25
15,0 mm	TS-272-26
20,0 mm	TS-272-27
25,0 mm	TS-272-28

STILLE
20,0 cm, 8"



10,0 mm	TS-273-29
15,0 mm	TS-273-30
20,0 mm	TS-273-31
25,0 mm	TS-273-32

STILLE
20,0 cm, 8"



10,0 mm	TS-273-33
15,0 mm	TS-273-34
20,0 mm	TS-273-35
25,0 mm	TS-273-36

STILLE
20,0 cm, 8"

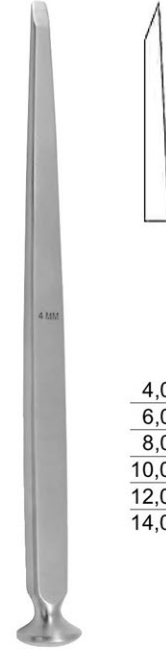

4,0 mm	TS-273-37
6,0 mm	TS-273-38
8,0 mm	TS-273-39
10,0 mm	TS-273-40
12,0 mm	TS-273-41
14,0 mm	TS-273-42

ALEXANDER
18,0 cm, 7"



4,0 mm	TS-273-43
6,0 mm	TS-273-44
8,0 mm	TS-273-45
10,0 mm	TS-273-46
12,0 mm	TS-273-47
14,0 mm	TS-273-48

ALEXANDER
18,0 cm, 7"



6,0 mm	TS-273-49
9,0 mm	TS-273-50
13,0 mm	TS-273-51
16,0 mm	TS-273-52
19,0 mm	TS-273-53
25,0 mm	TS-273-54
32,0 mm	TS-273-55

SMITH-PETERSEN
20,0 cm, 8"



6,0 mm	TS-273-56
9,0 mm	TS-273-57
13,0 mm	TS-273-58
16,0 mm	TS-273-59
19,0 mm	TS-273-60
25,0 mm	TS-273-61
32,0 mm	TS-273-62

SMITH-PETERSEN
20,0 cm, 8"



9,0 mm	TS-274-63
14,0 mm	TS-274-64
16,0 mm	TS-274-65
19,0 mm	TS-274-66
25,0 mm	TS-274-67

SMITH-PETERSEN
20,0 cm, 8"



9,0 mm	TS-274-68
14,0 mm	TS-274-69
16,0 mm	TS-274-70
19,0 mm	TS-274-71
25,0 mm	TS-274-72

SMITH-PETERSEN
20,0 cm, 8"



6,0 mm	TS-274-73
15,0 mm	TS-274-74
20,0 mm	TS-274-75
25,0 mm	TS-274-76
30,0 mm	TS-274-77
38,0 mm	TS-274-78
44,0 mm	TS-274-79
50,0 mm	TS-274-80

LAMBOTTE
24,0 cm, 9½"

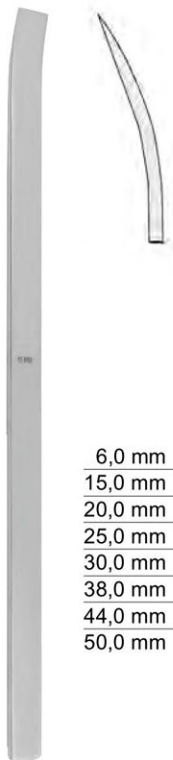

6,0 mm	TS-274-81
15,0 mm	TS-274-82
20,0 mm	TS-274-83
25,0 mm	TS-274-84
30,0 mm	TS-274-85
38,0 mm	TS-274-86
44,0 mm	TS-274-87
50,0 mm	TS-274-88

LAMBOTTE
24,0 cm, 9½"



COLLIN
20,0 cm, 8"
TS-274-89



PARTSCH
18,0 cm, 7"
TS-274-90

mit Bleifüllung
lead filled head
cabezal relleno de plomo
testa di piombo



BERGMANN
24,0 cm, 9½"
TS-274-92

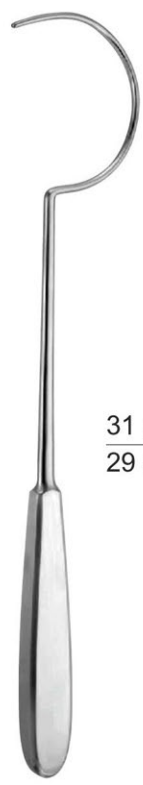

31 cm **TS-10-101**
29 cm **TS-10-102**

Demel Wire Guides



Loure Wire Tightener
21 cm

TS-10-103



**Demel Wire Tightener
and Twister, 27 cm**

TS-10-104



18 cm **TS-10-105**
26 cm **TS-10-106**

Kirschner Extension Bows
With 3 Traction Hooks



Kirschner Wire with Trocar Tip both End

15 cm, Ø1.0 mm	TS-10-107
15 cm, Ø1.2 mm	TS-10-108
15 cm, Ø1.4 mm	TS-10-109
15 cm, Ø1.5 mm	TS-10-110
15 cm, Ø1.6 mm	TS-10-111
15 cm, Ø1.8 mm	TS-10-112
15 cm, Ø2.0 mm	TS-10-113
15 cm, Ø2.5 mm	TS-10-114

10 cm, Ø1.0 mm	TS-10-115
10 cm, Ø1.2 mm	TS-10-116
10 cm, Ø1.4 mm	TS-10-117
10 cm, Ø1.5 mm	TS-10-118
10 cm, Ø1.6 mm	TS-10-119
10 cm, Ø1.8 mm	TS-10-120
10 cm, Ø2.0 mm	TS-10-121
10 cm, Ø2.5 mm	TS-10-122

7 cm, Ø1.0 mm	TS-10-123
7 cm, Ø1.2 mm	TS-10-124
7 cm, Ø1.4 mm	TS-10-125
7 cm, Ø1.5 mm	TS-10-126
7 cm, Ø1.6 mm	TS-10-127
7 cm, Ø1.8 mm	TS-10-128
7 cm, Ø2.0 mm	TS-10-129
7 cm, Ø2.5 mm	TS-10-130

30 cm, Ø1.0 mm	TS-10-131
30 cm, Ø1.2 mm	TS-10-132
30 cm, Ø1.4 mm	TS-10-133
30 cm, Ø1.5 mm	TS-10-134
30 cm, Ø1.6 mm	TS-10-135
30 cm, Ø1.8 mm	TS-10-136
30 cm, Ø2.0 mm	TS-10-137
30 cm, Ø2.5 mm	TS-10-138

25 cm, Ø1.0 mm	TS-10-139
25 cm, Ø1.2 mm	TS-10-140
25 cm, Ø1.4 mm	TS-10-141
25 cm, Ø1.5 mm	TS-10-142
25 cm, Ø1.6 mm	TS-10-143
25 cm, Ø1.8 mm	TS-10-144
25 cm, Ø2.0 mm	TS-10-145
25 cm, Ø2.5 mm	TS-10-146

23 cm, Ø1.0 mm	TS-10-147
23 cm, Ø1.2 mm	TS-10-148
23 cm, Ø1.4 mm	TS-10-149
23 cm, Ø1.5 mm	TS-10-150
23 cm, Ø1.6 mm	TS-10-151
23 cm, Ø1.8 mm	TS-10-152
23 cm, Ø2.0 mm	TS-10-153
23 cm, Ø2.5 mm	TS-10-154

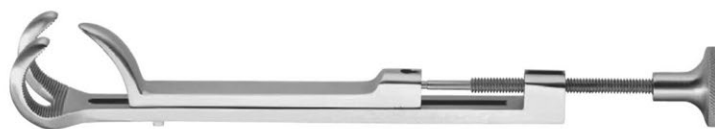

Lowman Bone Holding Clamp

18 cm	TS-10-155
20 cm	TS-10-156
23 cm	TS-10-157

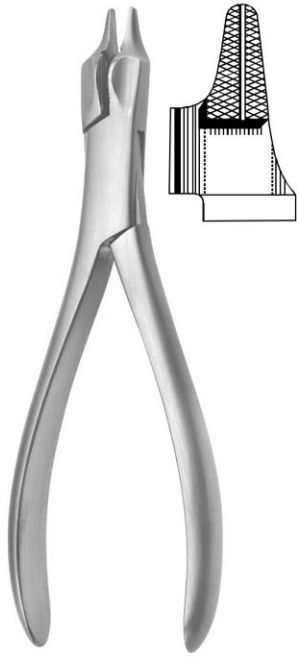

Combi-Flat Nose Plier
For Bending and Cutting,
15cm
TS-10-158



Flat Nose Plier
With Groove, 16cm
TS-10-159



Flat Nose Plier
Pointed, 19cm
TS-10-160



Flat Nose Plier
Pointed, 20cm
TS-10-161



Flat Nose Plier
Parallel Grip, 18cm
TS-10-162

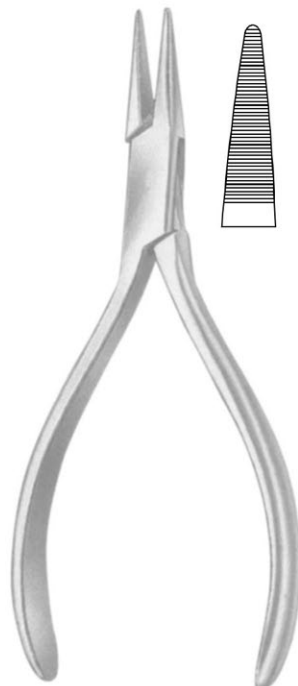

Flat Nose Plier, 14cm
TS-10-163



Flat Nose Plier, 17cm
TS-10-164



Wire Cutting Plier (TC)
For Soft Wires Up to 3.5 mm Ø,
For Hard Wires Up to 2.5 mm Ø
16 cm
TS-10-165



Wire Cutting Plier
For Soft Wires Up to 2.2 mm Ø,
For Hard Wires Up to 2.0 mm Ø
16 cm
TS-10-166



Wire Cutting Plier
For Soft Wires Up to 2.4 mm Ø,
For Hard Wires Up to 1.8 mm Ø
18 cm
TS-10-167



Wire Cutting Plier (TC)
For Soft Wires Up to 2.0 mm Ø,
For Hard Wires Up to 1.2 mm Ø
15 cm
TS-10-168



Wire Cutting Plier
For Soft Wires Up to 2.8 mm Ø,
For Hard Wires Up to 2.3 mm Ø
22.5 cm
TS-10-169



Wire Cutting Plier (TC)
For Soft Wires Up to 1.5 mm Ø,
For Hard Wires Up to 1.0 mm Ø
13 cm
TS-10-170

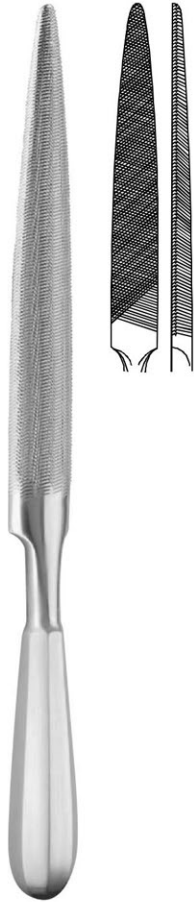

Bone File, Semi Round
28 cm

TS-10-171



Bone File, Semi Round
28 cm

TS-10-172



Putti Bone Rasp

Semi Round
30 cm

TS-10-173



Bone File, Semi Round
25 cm

TS-10-174



Bone File, Flat
22 cm

TS-10-175



Hohmann Bone Lever, Narrow Tip,
43mm, 22 cm
TS-10-176



Hohmann Bone Lever, Narrow Tip
8mm, 22 cm
TS-10-177

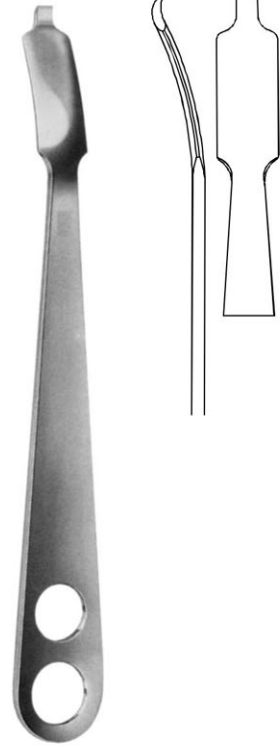

Wagner Bone Lever
22 cm
TS-10-178



Lane-Terthowan Bone Lever, 22 cm
TS-10-179

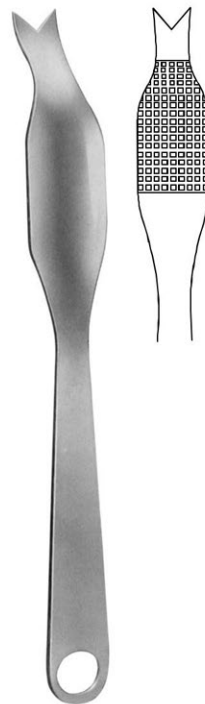

Schumacher Bone Lever, 18mm, 29 cm
TS-10-180



Molt Periosteal Elevator 4mm, 18 cm
TS-10-181



Mead Periosteal Elevator, 17 cm

TS-10-182



Ward Periosteal Elevator, 17 cm

TS-10-183

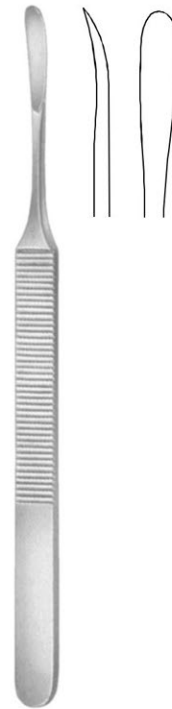

Keonig Periosteal Elevator, 15.5 cm

TS-10-184

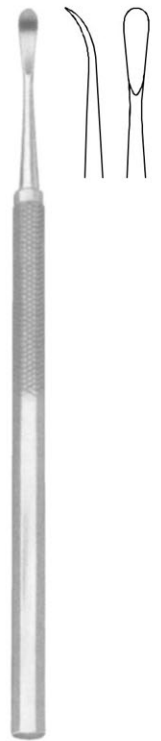

Partsch Mod, Lange Periosteal Elevator

4mm, 14.5 cm

TS-10-185

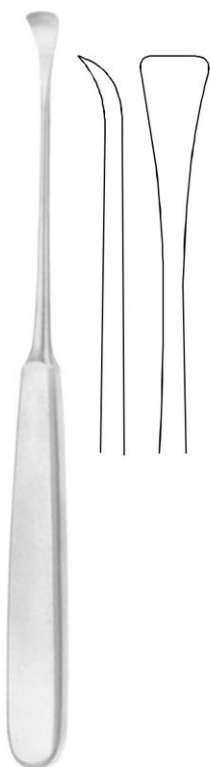

Buchs Periosteal Elevator, 9.5mm

19 cm

TS-10-186

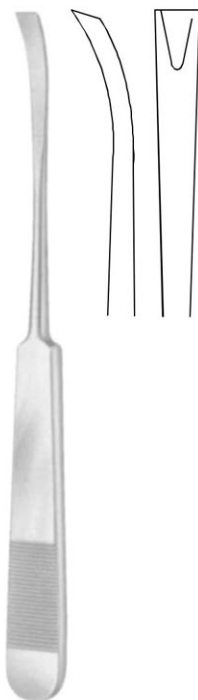

Pennybaker Periosteal Elevator, Blunt,

6mm, 16 cm

TS-10-187



Syme Periosteal Elevator, 4mm, 18 cm

TS-10-188

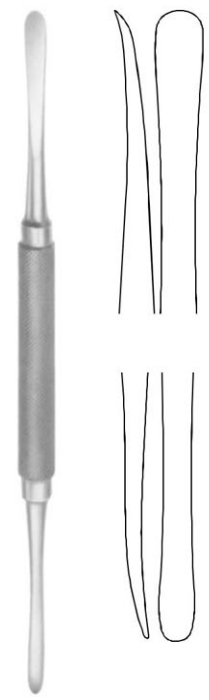

Molt Periosteal Elevator 4mm, 18 cm

TS-10-189

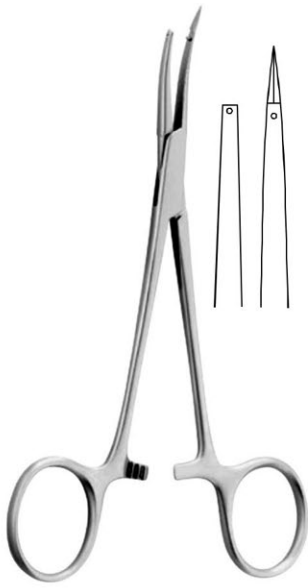

Tending Interlacing Forceps, Pointed
15 cm
TS-10-190



Kleinert-Kutz Tending Holding Forceps, 1 x 2 Teeth
21 cm
TS-10-191



Tending Holding Forceps
12 cm
TS-10-192

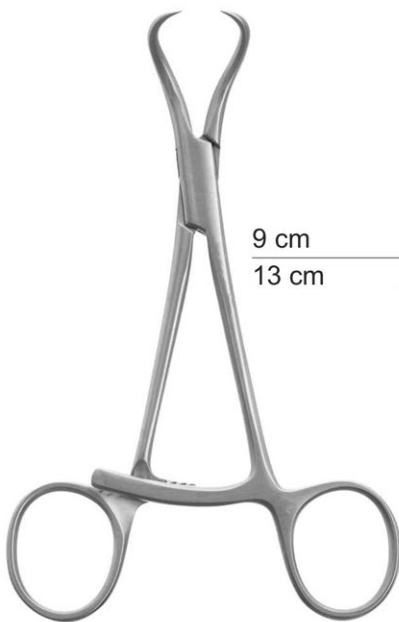

9 cm **TS-10-193**
13 cm **TS-10-194**

Repositioning Forceps
Long Ratchet, Pointed



Lewin Repositioning Forceps, 22 cm
TS-10-196



Repositioning Forceps
21 cm
TS-10-197

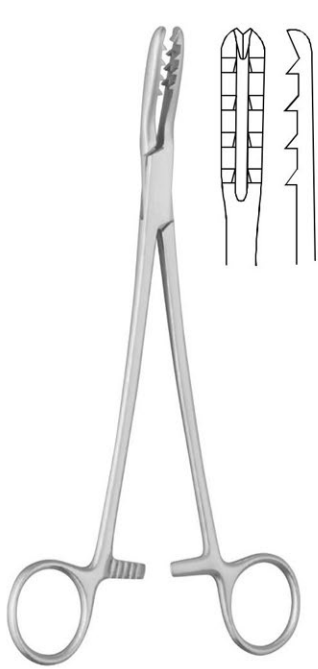

Van Buren Bone Holding Forceps, 23 cm
TS-10-198



Bone Holding Forceps
20 cm
TS-10-199



Fergusson Bone Holding Forceps
21 cm
TS-10-200



Langenbeck Bone Holding Forceps
23 cm
TS-10-201

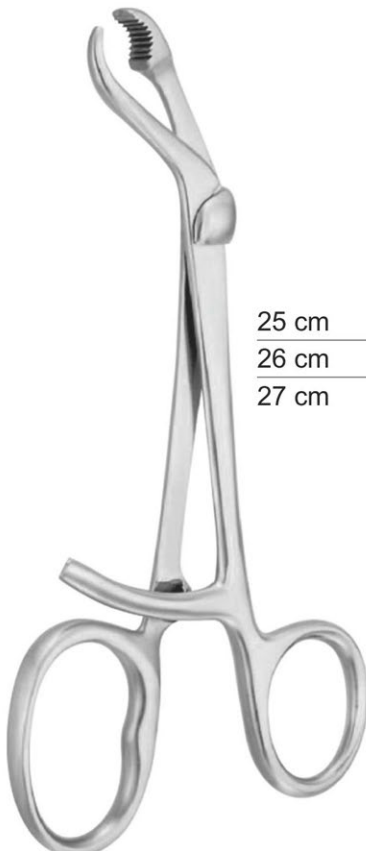

25 cm **TS-10-202**
26 cm **TS-10-203**
27 cm **TS-10-204**

Van Buren Bone Holding Forceps



Verbrugge Bone Holding Forceps
TS-10-205



Fergusson Bone Holding Forceps
21 cm
TS-10-206



Langenbeck Bone Holding Forceps
23 cm
TS-10-207



Cleveland Bone Rongeur, 14 cm
TS-10-208



Bohler Bone Rongeur, 16 cm
TS-10-209



Friedmann Bone Rongeur, 13 cm
TS-10-210



Stellbrink Bone Rongeur, 17 cm
TS-10-211



Blumenthal Bone Rongeur, 15 cm
TS-10-212



Lempert Bone Rongeur, 16 cm
TS-10-213



Jansen Bone Rongeur, 18 cm
TS-10-214



Hartmann Bone Rongeur, 17 cm
TS-10-215



**Cleveland Bone
Cutting Forceps**

14 cm **TS-10-216**
17 cm **TS-10-217**



**Liston Bone Cutting
Forceps, Straight**

14 cm **TS-10-218**
17 cm **TS-10-219**
20 cm **TS-10-220**
22 cm **TS-10-221**



**Cottle-Kazanjian Bone
Cutting Forceps, 17 cm**
TS-10-222



**Ruskin-Liston Bone
Cutting Forceps, 18 cm**
TS-10-223



**Bohler Bone Cutting
Forceps, 15 cm**
TS-10-224



**Stille-Liston Bone Cutting
Forceps, Curved, 27 cm**
TS-10-225



 **TABIB**
surgical

Phone: +92-325-815800

Email: info@tabibsurgical.com

Web: www.tabibsurgical.com

Address: 4/329 Murray College Road Sialkot